

# Instruction Manual

---

## Self-Cleaning Suspended 3-Fan Ioniser

(KS2453)



**Registered at Cardiff No. 2933918**  
**Registered Office:** Bondline Electronics, Unit 4,  
Rivermead Industrial Estate, Rivermead Drive,  
Swindon, Wiltshire, SN5 7EX

## Introduction

Thank you for purchasing a Self-Cleaning Suspended 3-Fan Ioniser. Please read this instruction manual in great detail before operating the device. Keep this manual readily accessible for later reference.

## Description

The KS2453 self-cleaning suspended 3-fan ioniser adopts DC working method and features a multi-unit independent ion transmitter combination, fan step-less speed regulation. The 3-fan ioniser is suitable for static removal in a large area, measuring 800 x 55 x 150mm (LxWxH) in size. It features a standard tungsten alloy needle which offers longer lifetime compared to titanium and silicon materials. The ioniser effectively solves the problems caused by static electricity: static removal, prevent adhesion of objects, prevent material splash, prevent static electricity and prevent blockage of feeder. Supplied with UK plug as standard, EU plug available on request.

| Properties            | Value  |
|-----------------------|--|
| Input Voltage         | AC220V/50Hz or 110V/60Hz   |
| Power                 | 18W  |
| Working Voltage       | ±DC4000-DC7000V  |
| Ion Emission          | Steady-state DC  |
| Emitter Electrode     | Tungsten Alloy   |
| Discharge Structure   | Uncoupled electrical contact (discharge cylinder)  |
| Discharge Range       | 800 x 300 x 750mm (LxWxH)  |
| Discharge Speed       | ≤3s (450mm vertical from the center of the air outlet)   |
| Ion Balance           | ≤ ±10V  (450mm vertical from the center of the air outlet)   |
| Alarm Indicator       | The power indicator light on indicates working normally  |
| Air Volume            | ≤ 3*89.1CFM  |
| Audio Noise           | ≤60db (150mm away from the air outlet)   |
| Ozone Thickness       | ≤0.05ppm (150mm from the air outlet)   |
| Operating Temperature | 0-50°C   |
| Operating Humidity    | 30-70%RH   |
| Dimensions            | 800 x 55 x 150mm (LxWxH) (Fan body size)   |
| Packaging Accessories | 1 pair of L-shaped aluminium spray powder mounting bracket, 1 pair of bakelite screw handles (M6×12) |
| Shell Material        | Aluminum powder spray  |
| Net Weight            | 2500g (Including power cord, bracket accessories, etc.)  |
| Gross Weight          | 4200g  |
| Warranty              | 1 Year   |
| Certification         | CE   |

| Discharge Effect | Value   |
|------------------|---|
| Test Standard    | ANSI/ESD.STM3.1, SJ/T 11446—2013                          |
| Test Instrument  | Trek 157 static tester                                    |
| Test Voltage     | $\pm 1000V \rightarrow \pm 100V$ attenuation              |
| Test Environment | Humidity 50 $\pm$ 5%; Temperature 23 $\pm$ 3 $^{\circ}$ C |

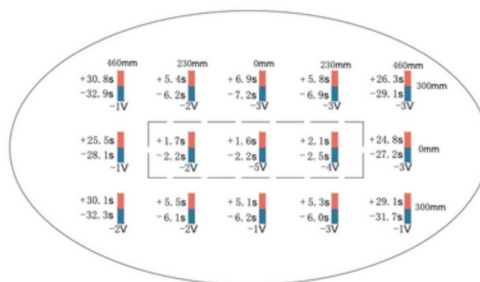

The test data as follows (test distance: 450mm in front, maximum air volume):

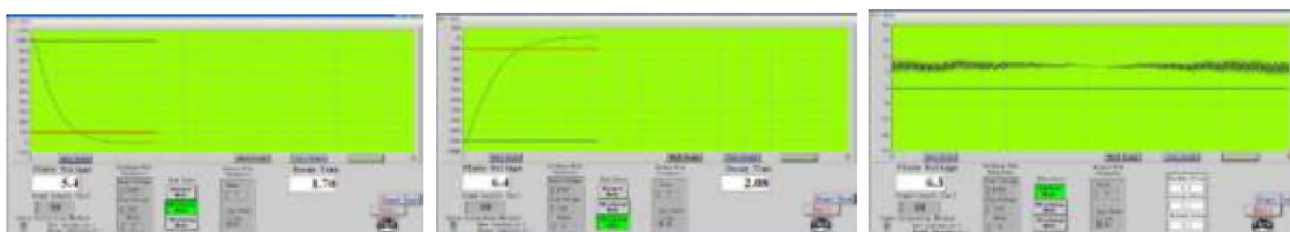

## Working Way

The KS2453 ioniser uses positive and negative synchronous emission electrodes to generate corona discharge through DC high voltage, ionize air molecules and generate a large number of positive and negative air ions, which are blown to the surface of the object with electrostatic to be eliminated by the fan.

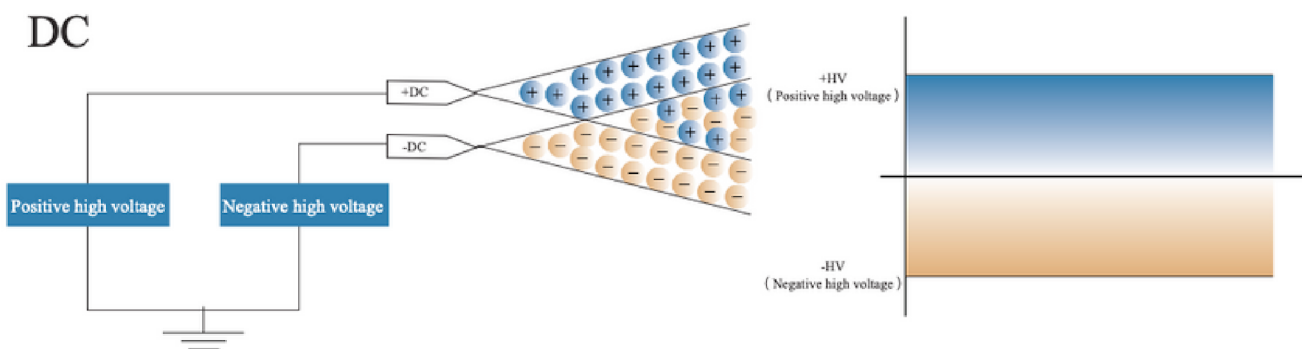

## Product Details

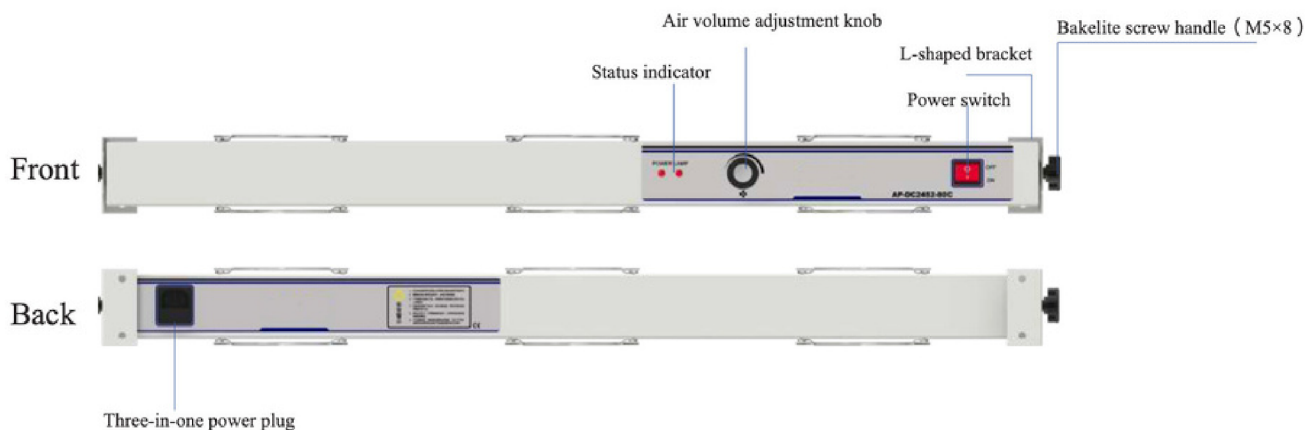

## Product Dimensions

**Note:** The outside drawing may change slightly due to improvement. They should comply with the real device.

Unit: mm

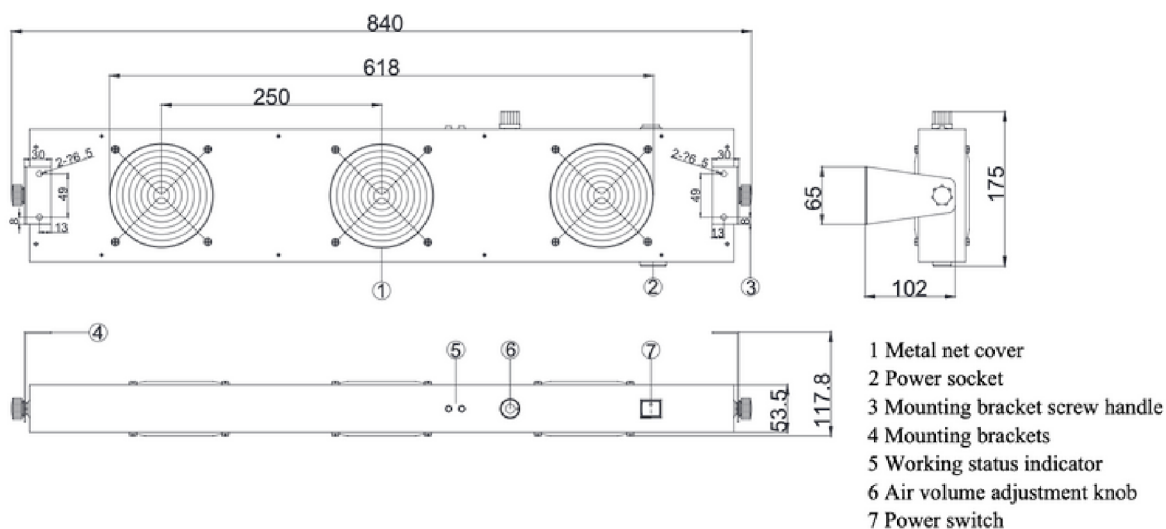

## Installation

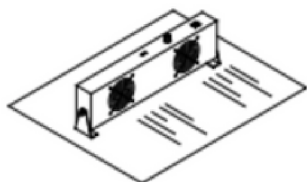
**1**

Use screws or bolts to fix on a firm and flat surface (such as a wall or shelf).

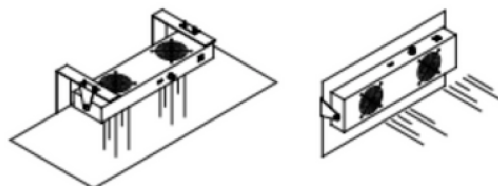
**2**

The angle of ionising air blower can be adjusted by the knobs on both sides of the bracket to achieve the best static elimination effect.

## Installation Tips

**1.** Place the ionising air blower in the working area where static electricity is to be eliminated. The installation angle should be perpendicular to the surface of the charged body and about 300 to 750mm away from the static electricity object.

**2.** Ionising air blower should be at least 300mm away from the metal conductor and metal grounding body.

**3.** Two ionising air blowers should be installed side by side with an interval of more than 200mm away from obstacles.

**4.** The air inlet is at least 150mm away from the wall.

## Packing Accessories

| Part Name                    | Picture   | Specification                 |
|------------------------------|---|-------------------------------|
| National standard power cord |  | Standard 1.8m, optional 3m/5m |

## Safety Warning

1. Read the operating instruction carefully before installing and using the device.
2. The whole equipment must be reliably grounded during use.
3. Do not use the device when the humidity is higher than 70%.
4. Do not use the device in inflammable and explosive environment.
5. It is strictly forbidden to disassemble products without authorization. Internal maintenance and repair must be carried out by professional personnel.
6. The product is strictly prohibited to touch liquid during use, otherwise there will be abnormal, resulting in electric shock or fire.
7. Power must be turned off during inspecting or replacing the product, otherwise it may cause electric shock or fire.
8. The product is specially designed for removing static electricity and is strictly prohibited for other purposes. Any abnormal use may cause machine failure, electric shock, fire and other hidden dangers.
9. It is strictly forbidden to touch the electrode needles when power is on, otherwise it is easy to cause fault and electric shock accident.
10. Discharge needle is a sharp metal object, please use it with care.
11. Please check the specifications of the power supply before powering on the product. Any power supply that does not meet the specifications may cause damage or even failure to the product.
12. Check the power cord and communication line regularly. If it is damaged, replace it immediately; otherwise, leakage, poor communication and abnormal operation may occur.

## Trouble Shooting

| No. | Problems   | Reasons  | Solutions  |
|-----|--|--|--|
| 1   | The indicator on the fan panel is off                      | Poor contact of the power cable<br><br>Power supply voltage mismatch                           | Check whether the power cable is in good condition and securely connected<br><br>Confirm the power supply specification<br>INPUT:220VAC 50Hz |
| 2   | The electrostatic removal performance is obviously reduced | Discharge needle is polluted and damaged<br><br>Bearing set of ionising air blower is improper | Clean or replace the discharge needle<br><br>Confirm the best bearing set  |
| 3   | The electrostatic removal performance is reduced           | There are conductors or other ionising air blowers around                                      | Remove (moving) conductors or other ionising air blowers   |
| 4   | Unable to discharge  | High voltage module is damaged<br><br>Main-board chip is damaged                               | Return to factory for maintenance<br><br>Return to factory for maintenance   |
| 5   | The product is smoky or burnt                              | The main control board components are burnt out  | Return to factory for maintenance  |



## Maintenance

---

1) The ionising air blower should be cleaned and maintained in time according to the use environment and the required electrostatic protection requirements in order to ensure the good performance of the product. That is, gently remove the carbon deposits on the discharge electrode and metal net cover with electrostatic brush, dust-free cotton swab, dust-free cloth dipped in anhydrous alcohol.

**Note:**

**A.** Operation must be done 10 minutes after power cut off.

**B.** It must be cleaned when dust or white stuff appear on the tip of the needle during use.

**C.** The ionising air blower must be powered on after alcohol is completely volatilized after cleaning. No other organic solvent can be used to clean the ionizing air blower.

**D.** The alloy electrode is a consumable product which is not included in the scope of warranty and will be charged for replacement when repairing.

2) Do not press or rotate the control buttons on the fan panel too hard; otherwise, the device will be permanently damaged.

3) If the working indicator light on the front panel of the fan is off or red, it should be stopped and repaired by professional maintenance personnel. It can be used only after the electrical performance index is normal.

## After-Sales Service

---

1) KS2453 self-cleaning suspended 3-fan ioniser has undergone rigorous testing and ageing treatment before ex-work. Its performance has completely reached the relevant indicators marked in the usage instruction.

2) Bondline makes a commitment to the customer that any defective parts inspected by Bondline will be repaired or replaced free of charge within one year from the date of purchase. However, this commitment does not apply to: The device is incorrectly used or installed; Damage caused by negligence or accident during use; Modified, disassembled or repaired by other service departments not authorised by Bondline Electronics Ltd.

3) Bondline shall not be liable for any incorrect use of the products except for repair or replacement of parts as specified above.