

Instruction Manual

Self-Cleaning Suspended 2-Fan Ioniser

(KS2452)



Registered at Cardiff No. 2933918
Registered Office: Bondline Electronics, Unit 4,
Rivermead Industrial Estate, Rivermead Drive,
Swindon, Wiltshire, SN5 7EX

Introduction

Thank you for purchasing a Self-Cleaning Suspended 2-Fan Ioniser. Please read this instruction manual in great detail before operating the device. Keep this manual readily accessible for later reference.

Description

The KS2452 self-cleaning suspended 2-fan ioniser adopts DC working method and features a two-unit independent ion transmitter combination with step-less speed regulation. The 2-fan ioniser is excellent for electrostatic elimination in large areas, measuring 600 x 55 x 150mm (LxWxH) in size. During operation, the ionising air blower automatically brushes the needle every 8 hours without manual brush cleaning and maintenance. The KS2452 is CE certified ensuring a high-security and high-reliability static eliminator. Supplied with UK power supply as standard, EU power supply available on request.

Properties	Value
Input Voltage	AC220V/50Hz or 110V/60Hz
Power	<15W
Working Voltage	±DC4000-DC7000V
Ion Emission	Steady-state DC
Emitter Electrode	Tungsten Alloy
Discharge Structure	Uncoupled electrical contact (discharge cylinder)
Discharge Range	600 x 300 x 750mm (LxWxH)
Discharge Speed	≤3s (450mm vertical from the center of the air outlet)
Ion Balance	≤ ±10V (450mm vertical from the center of the air outlet)
Alarm Indicator	The power indicator light on indicates working normally
Air Volume	≤2*89.1CFM
Audio Noise	≤55db (150mm from the air outlet)
Ozone Thickness	≤0.05ppm (150mm from the air outlet)
Operating Temperature	0-50°C
Operating Humidity	30-70%RH
Dimensions	600 x 175 x 53.5mm (LxWxH) (Fan body size)
Packaging Accessories	1 pair of L-shaped aluminium spray powder mounting bracket, 1 pair of bakelite screw handles (M6×12)
Shell Material	Aluminum powder spray
Net Weight	2450g (including power cord, bracket accessories, etc.)
Gross Weight	3650g
Quality Assurance	1 Year
Certification	CE

Discharge Effect	Value
Test Standard	ANSI/ESD.STM3.1, SJ/T 11446—2013
Test Instrument	Trek 157 static tester
Test Voltage	±1000V → ±100V attenuation
Test Environment	Humidity 50±5%; Temperature 23±3°C

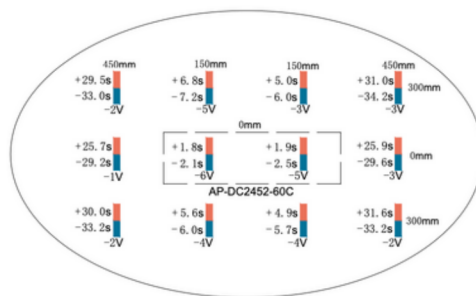

The test data as follows (test distance: 450mm in front, maximum air volume):

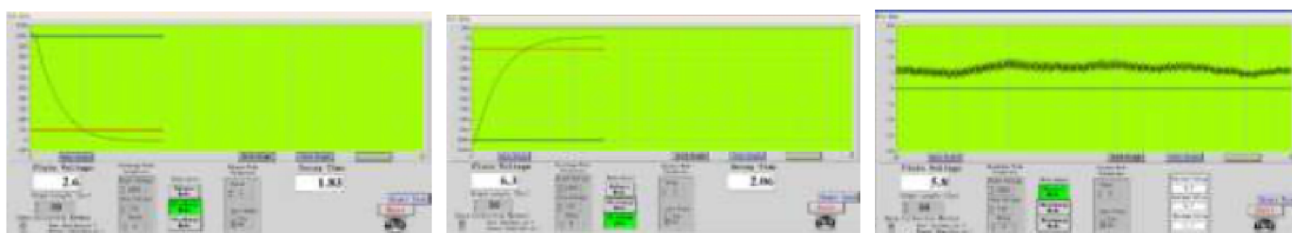

Working Way

The KS2452 ioniser uses positive and negative synchronous emission electrodes to generate corona discharge through DC high voltage, ionize air molecules and generate a large number of positive and negative air ions, which are blown to the surface of the object with electrostatic to be eliminated by the fan.

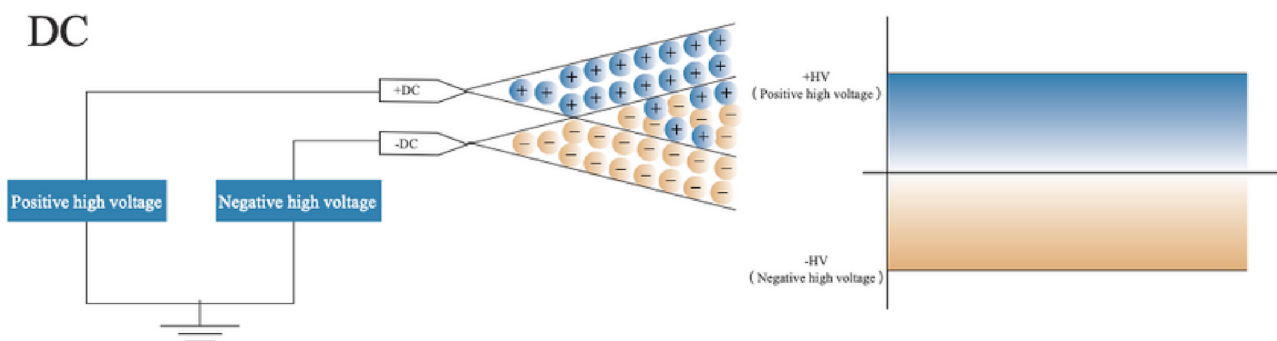

Product Details

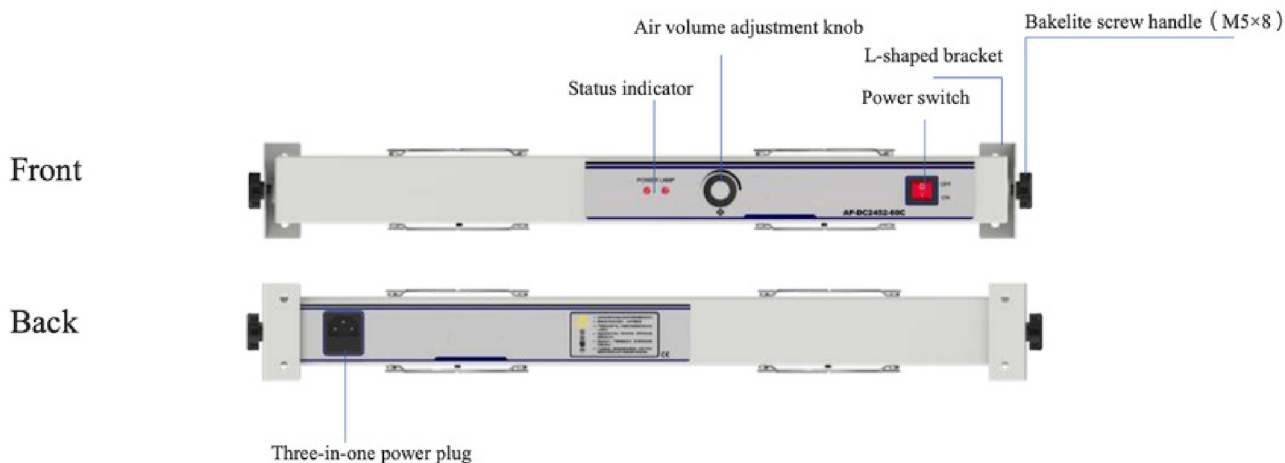

Product Dimensions

Note: The outside drawing may change slightly due to improvement. They should comply with the real device.

Unit: mm

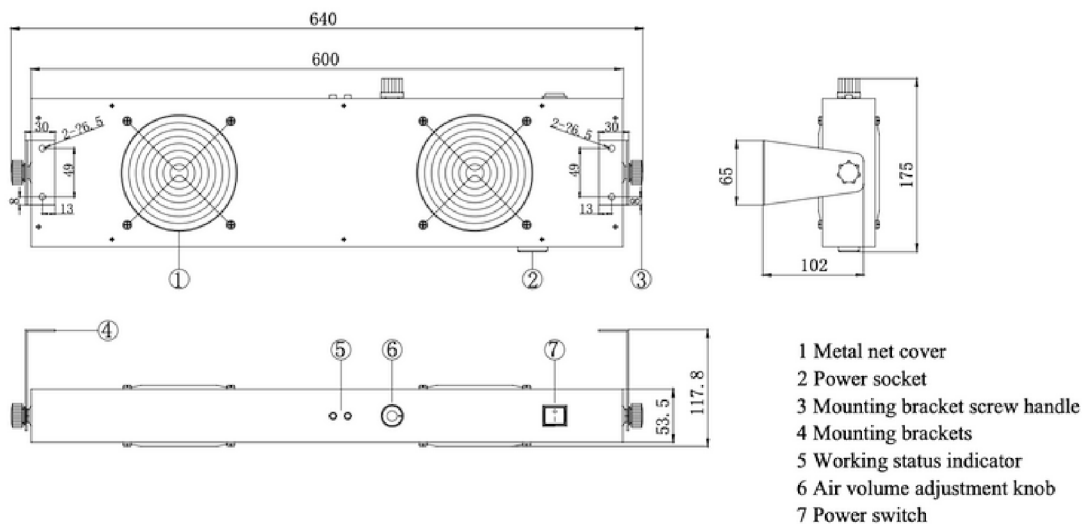

Installation

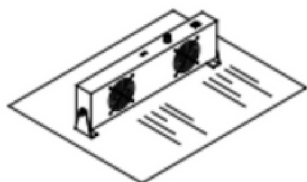
**1**

Use screws or bolts to fix on a firm and flat surface (such as a wall or shelf).

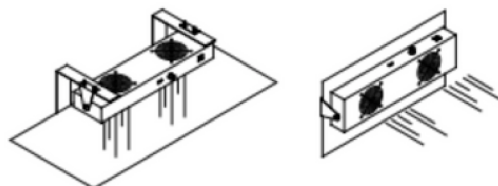
**2**

The angle of ionising air blower can be adjusted by the knobs on both sides of the bracket to achieve the best static elimination effect.

Installation Tips

1. Place the ionising air blower in the working area where static electricity is to be eliminated. The installation angle should be perpendicular to the surface of the charged body and about 300 to 750mm away from the static electricity object.

2. Ionising air blower should be at least 300mm away from the metal conductor and metal grounding body.

3. Two ionising air blowers should be installed side by side with an interval of more than 200mm away from obstacles.

4. The air inlet is at least 150mm away from the wall.

Packing Accessories

Part Name	Picture	Specification
National standard power cord		Standard 1.8m, optional 3m/5m

Safety Warning

1. Read the operating instruction carefully before installing and using the device.
2. The whole equipment must be reliably grounded during use.
3. Do not use the device when the humidity is higher than 70%.
4. Do not use the device in inflammable and explosive environment.
5. It is strictly forbidden to disassemble products without authorization. Internal maintenance and repair must be carried out by professional personnel.
6. The product is strictly prohibited to touch liquid during use, otherwise there will be abnormal, resulting in electric shock or fire.
7. Power must be turned off during inspecting or replacing the product, otherwise it may cause electric shock or fire.
8. The product is specially designed for removing static electricity and is strictly prohibited for other purposes. Any abnormal use may cause machine failure, electric shock, fire and other hidden dangers.
9. It is strictly forbidden to touch the electrode needles when power is on, otherwise it is easy to cause fault and electric shock accident.
10. Discharge needle is a sharp metal object, please use it with care.
11. Please check the specifications of the power supply before powering on the product. Any power supply that does not meet the specifications may cause damage or even failure to the product.
12. Check the power cord and communication line regularly. If it is damaged, replace it immediately; otherwise, leakage, poor communication and abnormal operation may occur.

Trouble Shooting

No.	Problems	Reasons	Solutions
1	The indicator on the fan panel is off	Poor contact of the power cable Power supply mismatch	Check whether the power cable is in good condition and securely connected Confirm the power supply specification
2	The electrostatic removal performance is obviously reduced	Discharge needle is polluted and damaged Bearing set of ionising air blower is improper	Clean or replace the discharge needle Confirm the best bearing set
3	The electrostatic removal performance is reduced	There are conductors or other ionising air blowers around	Remove (moving) conductors or other ionising air blowers
4	Unable to discharge	High voltage module is damaged Main-board chip is damaged	Return to factory for maintenance Return to factory for maintenance
5	The product is smoky or burnt	The main control board components are burnt out	Return to factory for maintenance

Maintenance

1) The ionising air blower should be cleaned and maintained in time according to the use environment and the required electrostatic protection requirements in order to ensure the good performance of the product. That is, gently remove the carbon deposits on the discharge electrode and metal net cover with electrostatic brush, dust-free cotton swab, dust-free cloth dipped in anhydrous alcohol.

Note:

A. Operation must be done 10 minutes after power cut off.

B. It must be cleaned when dust or white stuff appear on the tip of the needle during use.

C. The ionising air blower must be powered on after alcohol is completely volatilized after cleaning. No other organic solvent can be used to clean the ionizing air blower.

D. The alloy electrode is a consumable product which is not included in the scope of warranty and will be charged for replacement when repairing.

2) Do not press or rotate the control buttons on the fan panel too hard; otherwise, the device will be permanently damaged.

3) If the working indicator light on the front panel of the fan is off or red, it should be stopped and repaired by professional maintenance personnel. It can be used only after the electrical performance index is normal.

After-Sales Service

1) KS2452 self-cleaning suspended 2-fan ioniser has undergone rigorous testing and ageing treatment before ex-work. Its performance has completely reached the relevant indicators marked in the usage instruction.

2) Bondline makes a commitment to the customer that any defective parts inspected by Bondline will be repaired or replaced free of charge within one year from the date of purchase. However, this commitment does not apply to: The device is incorrectly used or installed; Damage caused by negligence or accident during use; Modified, disassembled or repaired by other service departments not authorised by Bondline Electronics Ltd.

3) Bondline shall not be liable for any incorrect use of the products except for repair or replacement of parts as specified above.